

www.bestarlighting.com

BESTAR LIGHTING

Email: info@bestar-lighting.com

Sales office :
Address: 15-16th/FI., A10 building, 777 JianZhu West Rd., Wuxi, Jiangsu
P.R., China
Tel: +86-510-82305188 Ext. 8080
Fax: +86-510-82390154

Factory(Wuxi):
Address: Chang Da Xia Industrial Zone, Chunsun Road, Dongting Town,
Wuxi, Jiangsu, China

Factory(Foshan):
Address: Xiangnan Road, Nansha, Foshan, Guangdong, China

2 0 1 9 / 2 0 2 0

*B*ESTYLE
LIGHTING



Complete One-stop Lighting Solution

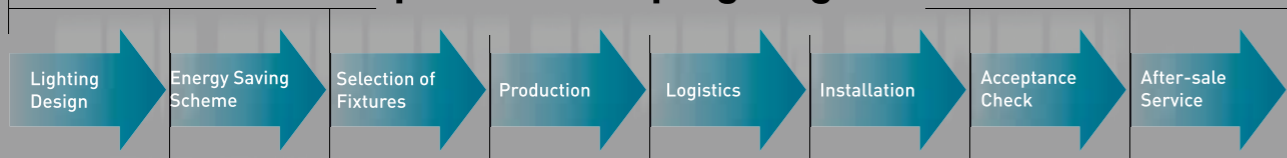

BESTYLE Lighting was established in 1995, the only brand under the CMEC Renewable energy, whose head office is located in Wuxi National IC Design Park with products series ranging from LED spot light, LED downlight, LED wall light, LED track light, LED ground light, industrial light and customized product. The diversity and fashion of the products fully meet different requirements to a broad market. As the integrator and the idea-supplier of modern illumination, BESTYLE is always ready for projects of office lighting, commercial lighting, hotel lighting, industrial light, intelligent control system and other areas.

BESTYLE provides one-stop service for both international and domestic commercial projects, such as designing, specification, customization, delivering, installing and after-sales service. We have capacity for Energy Performance Contracting (EPC) to provide the wider service for our customers in the area of New Energy Lighting.

Nowadays, with the exploding market of LED technology, BESTYLE has modern factories equipped with leading

edge testing equipment and dedicated team to follow up the lighting trends to deliver the best solutions tailored to each market. To meet high-quality requirements of customers, BESTYLE has been under strict inspection and control beginning with section of top grade raw material, inspection, delivery and after-sale service to reach 100% satisfaction from our customers.

BESTYLE owns talented production and management team, who are with advanced strategic thinking and modern management concept, lead to a large scale growth in the international lighting market. As strategic partners of a number of famous companies, BESTYLE has stepped in the international high-end project market with products being sold to more than 100 countries and regions.

Innovation is our greatest motivation, driving us to pursue fashionable products and exceptional brightness in lighting. We will focus on our advantages as before, and aim to create the green innovative, fashionable and comfortable products in the market.

2019 / 2020

	LED Track Light P2-15
	LED Downlight P16-25
	LED Spot Light P26-27
	Spot Light Fixture P28-35
	LED Commercial Light P36-44
	LED Wall Light P45-59
	LED Outdoor Light P60-75
	LED Lighting Source P76-79

Max

- * Complete series of track lighting. Focusing on the most professional optical design combining the chic appearance design.
- * Same head design in different forms, including track series, recessed series, surface mounted series, hanging series.
- * Several TOP technologies.
- * One-stop solution meets all requirements from projects of shops, museums, hotels.

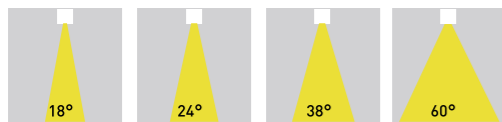

LBS2457

220V 240V	50/60 Hz	30W	2700K 5000K	2700lm	Ra > 80	PF 0.95	

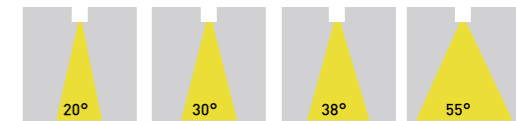
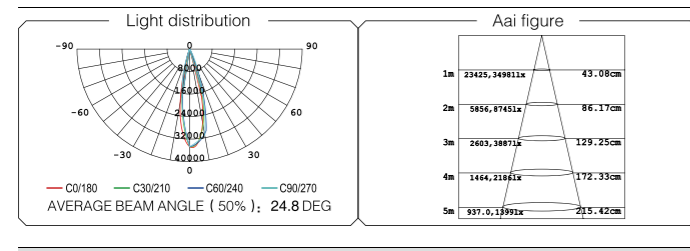

LBS2456

220V 240V	50/60 Hz	20W	2700K 5000K	1800lm	Ra > 80	PF 0.95	

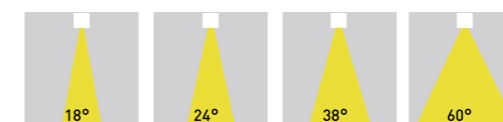

LBS2458

220V 240V	50/60 Hz	33W	2700K 5000K	3000lm	Ra > 80	PF 0.95	



One-piece

- * Smart design-without driver box
- * 12W/20W/30W/33W
- * Different sizes, full range for option



30w

LBS2449

220V 240V	50/60 Hz	30W	2700K 5000K	2400lm	Ra > 80	PF 0.95	⏚
Aluminum	↑	COB	IP20	36°			

Light distribution

AVERAGE BEAM ANGLE (50%); 36.5 DEG

Aai figure

1m	11315.16772 lx	65.58cm
2m	2829.4193 lx	131.15cm
3m	1257.1864 lx	196.73cm
4m	707.21048 lx	262.30cm
5m	452.6.670.9 lx	327.88cm

12w

LBS2447

220V 240V	50/60 Hz	12W	2700K 5000K	1400lm	Ra > 80	PF 0.95	⏚
Aluminum	↑	COB	IP20	36°			

20w

LBS2448

220V 240V	50/60 Hz	20W	2700K 5000K	1400lm	Ra > 80	PF 0.95	⏚
Aluminum	↑	COB	IP20	36°			

33w

LBS2450

220V 240V	50/60 Hz	33W	2700K 5000K	2440lm	Ra > 80	PF 0.95	⏚
Aluminum	↑	COB	IP20	36°			

LED Track Light

RECESSED VERSION

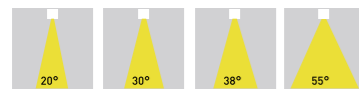

LBS2456C

220V 240V	50/60 Hz	20W	2700K - 5000K	1800lm	Ra > 80	PF 0.95	

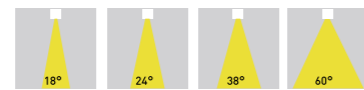

LBS2457C

220V 240V	50/60 Hz	30W	2700K - 5000K	2700lm	Ra > 80	PF 0.95	

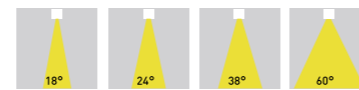

LBS2458C

220V 240V	50/60 Hz	33W	2700K - 5000K	3000lm	Ra > 80	PF 0.95	

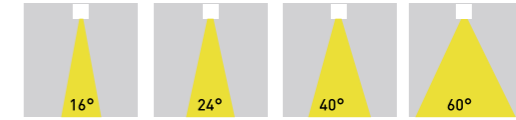

LBS2459

220V 240V	50/60 Hz	33W	2700K - 5000K	2800lm	Ra > 80	PF 0.95	

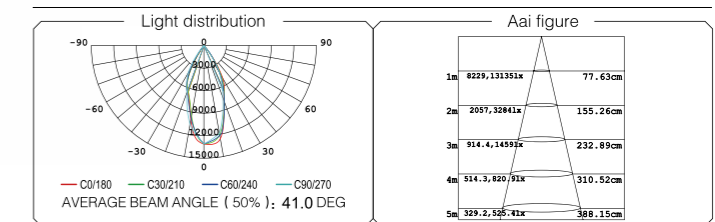

SURFACE MOUNTED VERSION

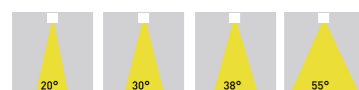

LBS2456M

220V 240V	50/60 Hz	20W	2700K - 5000K	1800lm	Ra > 80	PF 0.95	

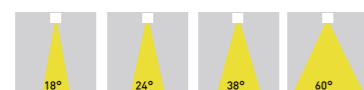

LBS2457M

220V 240V	50/60 Hz	30W	2700K - 5000K	2700lm	Ra > 80	PF 0.95	

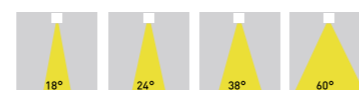

LBS2458M

220V 240V	50/60 Hz	33W	2700K - 5000K	3000lm	Ra > 80	PF 0.95	

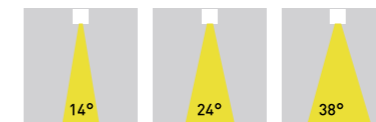

LBS2460

220V 240V	50/60 Hz	38W	2700K - 5000K	4000lm	Ra > 80	PF 0.95	

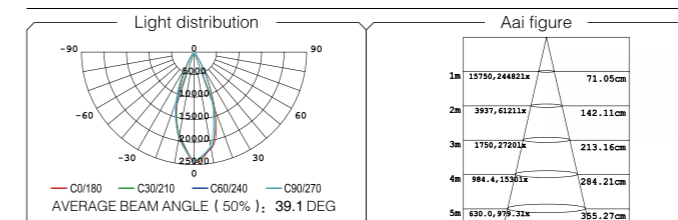

LED Track Light

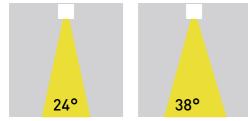

LBS2461

220V 240V	50/60 Hz	15W	2700K 5000K	1350lm	Ra > 80	PF 0.95	

LBS2462

220V 240V	50/60 Hz	30W	2700K 5000K	2400lm	Ra > 80	PF 0.95	

30w

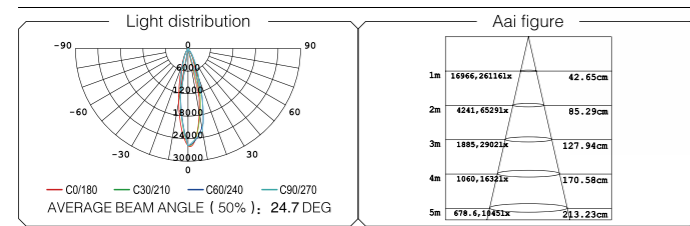

BESTYLE LIGHTING

CE RoHS

TYPE A HIGH ILLUMINATION



Light pipe + reflector design;
Light utilization rate is more than 95%;
perfectly symmetrical light distribution curve;
Clean and pure light spot;
Naturally transitional halo;
It solved the problems of light quality in COB commercial lighting.

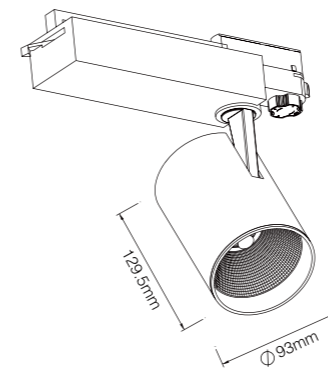

LBS2435A

220V 240V	50/60 Hz	22W	3000K 1700lm	Ra > 80	PF 0.95	

22w

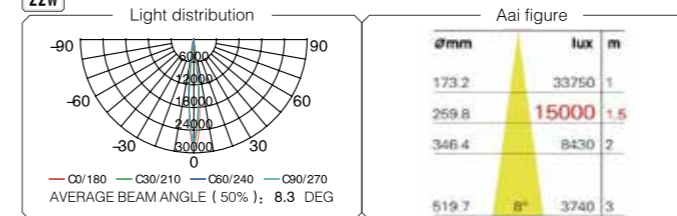

BEAM ANGLE 8°

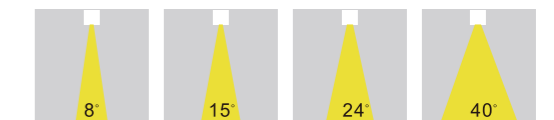

Central lux is 15000 in 1.5m, equals to the lux of Philips 70W

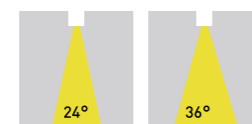

LBS2463

220V 240V	50/60 Hz	24W	2700K 5000K	2000lm	Ra > 80	PF 0.95	

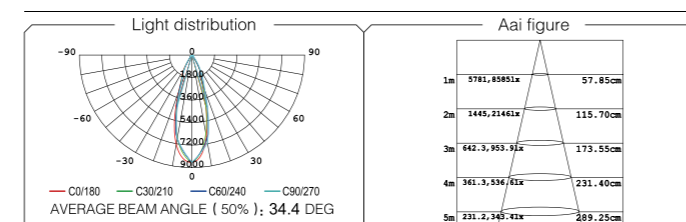

LED Track Light

TYPE B HIGH LUMEN OUTPUT

OPTICAL LENS SOLUTION

110 LM/W

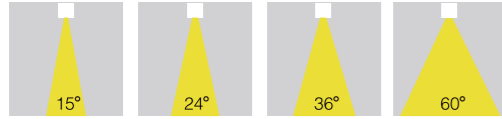

Model	Power (W)	Voltage (V)	CCT (K)	Lumen (±10%)	CRI	PF
LBS2434B	18	AC 220~240	3000	1700	>80	>0.95
LBS2435B	30	AC 220~240	3000	3300	>80	>0.95
LBS2436B	40	AC 220~240	3000	4500	>80	>0.95

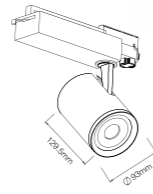
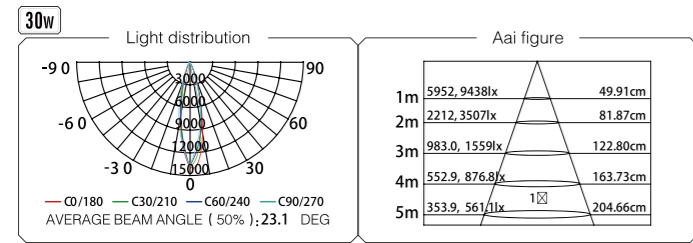

LBS2435B

220V/240V	50/60 Hz	30W	3000K	3300lm	Ra>80	PF 0.95	Earth symbol
Aluminum	↑	COB	IP20	24h	24h		



Model	Wattage	Type
LBS2434C	18W	B/C
LBS2435C	22W/30W	A/B/C
LBS2436C	40W	B/C

TYPE C REFLECTOR MODEL

CLASSIC REFLECTOR + COB DESIGN

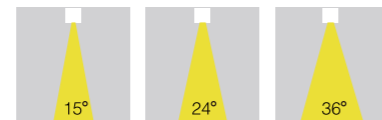

Model	Power (W)	Voltage (V)	CCT (K)	Lumen (±10%)	CRI	PF
LBS2434	18	AC 220~240	3000	1600	>80	>0.95
LBS2435	30	AC 220~240	3000	2800	>80	>0.95
LBS2436	40	AC 220~240	3000	3600	>80	>0.95

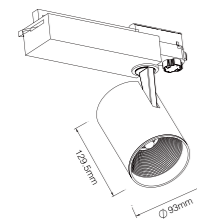
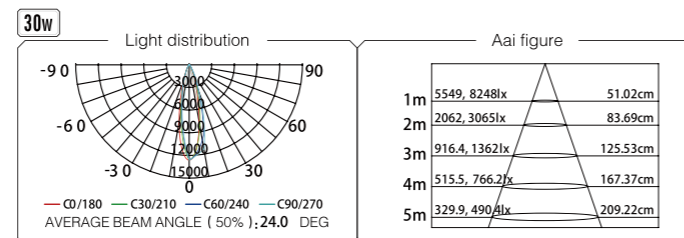

LBS2435

220V/240V	50/60 Hz	30W	3000K	2800lm	Ra>80	PF 0.95	Earth symbol
Aluminum	↑	COB	IP20	24h	24h		

Model	Wattage	Type
LBS2434M	18W	B/C
LBS2435M	22W/30W	A/B/C
LBS2436M	40W	B/C



Model	Wattage	Type
LBS2434D	18W	C

BESTYLE LIGHTING

CE RoHS

LED Track Light

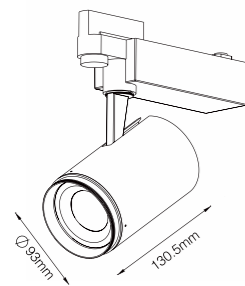
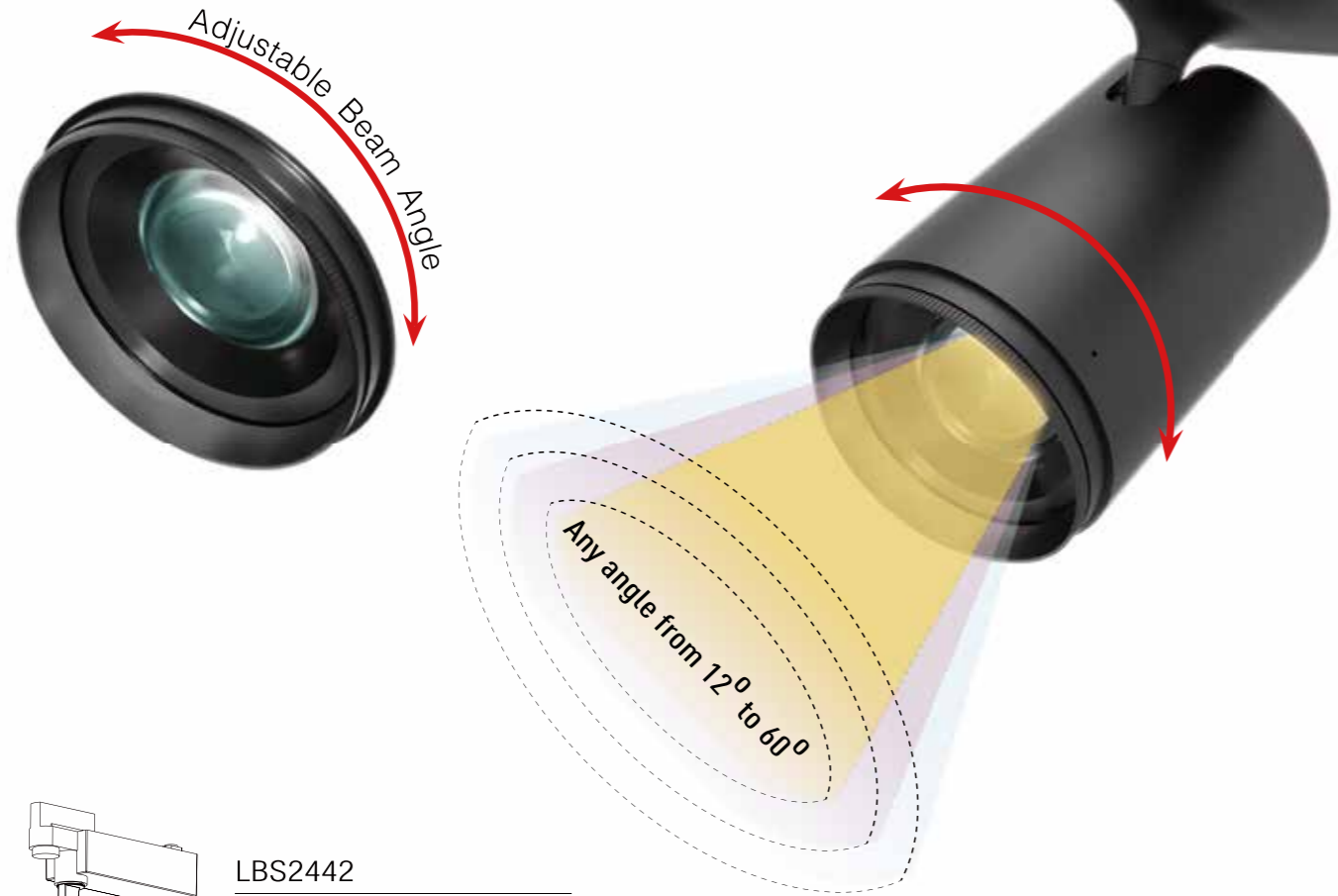

LBS2442

220V 240V	50/60 Hz	30W	3000K 4000K	Ra> 95	PF 0.95	

LBS2440



LBS2440M

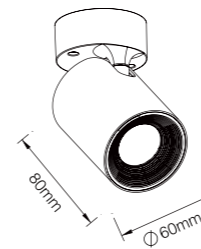

220V 240V	50/60 Hz	5W	3000K 3500K	Ra> 80	PF 0.5	

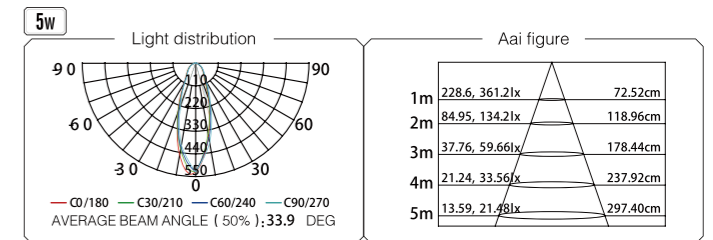

TRACK

Model	Power (W)	CCT (K)	Lumen (±10%)
LBS2440-5	5	3000	350
LBS2440-7	7	3000	500

SURFACE MOUNTED

Model	Power (W)	CCT (K)	Lumen (±10%)
LBS2440M-5	5	3000	350
LBS2440M-7	7	3000	500

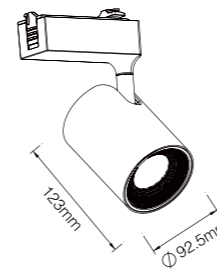

LBS2441

220V 240V	50/60 Hz	30W	3000K 3500K	Ra> 80	PF 0.9	



Poly



TRACK

XM2401



SURFACE MOUNTED

XM2401M

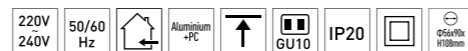

OPTIONAL LIGHTING SOURCE



GY-2207C



GY-2223



TRACK

XM2402



SURFACE MOUNTED

XM2402M



SURFACE MOUNTED

XM2402M-2



Ever

- * LED recessed luminaire - Simple and elegant appearance.
- * Various powers and sizes for different requirement. Dimmable or Non-dimmable available.
- * High CRI, high efficiency, high illumination.
- * Applied to shopping mall, hotel, exhibition hall, museum, office, hospital, airport, school and etc.

COB



LXM2157-S

100V 240V	50/60 Hz	25W	2700K 5000K	2000lm	Ra > 80	PF 0.95	

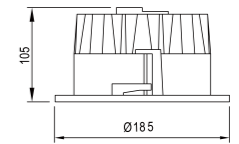

Light distribution

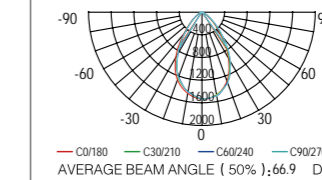

Aai figure

1m	2228.3921 lx	132.27cm
2m	557.1980.2 lx	264.54cm
3m	247.6.435.6 lx	396.81cm
4m	139.3.245.0 lx	529.08cm
5m	89.14.156.8 lx	661.35cm



LXM2157-C

100V 240V	50/60 Hz	33W	2700K 5000K	3300lm	Ra > 80	PF 0.95	

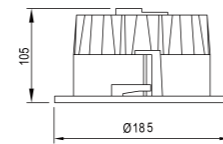

Light distribution

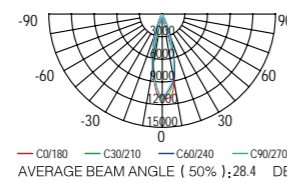

Aai figure

1m	23747.35991 lx	50.24cm
2m	5937.8998 lx	100.49cm
3m	2639.3999 lx	150.73cm
4m	1484.2249 lx	200.98cm
5m	949.9.1440 lx	251.22cm

LXM2158-C

100V 240V	50/60 Hz	42W	2700K 5000K	3700lm	Ra > 80	PF 0.95	

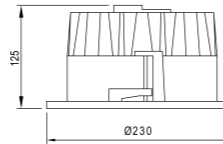

Light distribution

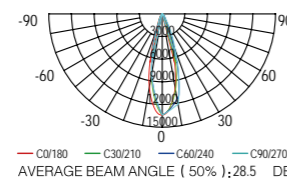

Aai figure

1m	37865.56059 lx	50.30cm
2m	9466.14015 lx	100.60cm
3m	4207.6229 lx	150.90cm
4m	2367.3504 lx	201.20cm
5m	1515.2242 lx	251.50cm



SMD

LXM2158-S

100V 240V	50/60 Hz	35W	2700K 5000K	2800lm	Ra > 80	PF 0.95	

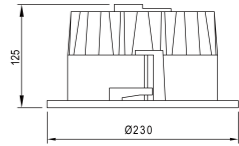

Light distribution

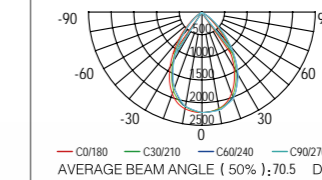

Aai figure

1m	4291.7773 lx	141.18cm
2m	1073.1943 lx	282.36cm
3m	476.8863.6 lx	423.54cm
4m	268.2.485.8 lx	564.72cm
5m	171.7.310.9 lx	705.90cm

LED Downlight

COB



LXM2165C

220V 240V	50/60 Hz	22W 28W 30W	2700K 3000K 4000K 5000K	2000lm 2550lm 2700lm	Ra > 80	PF 0.90	

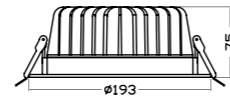

30W

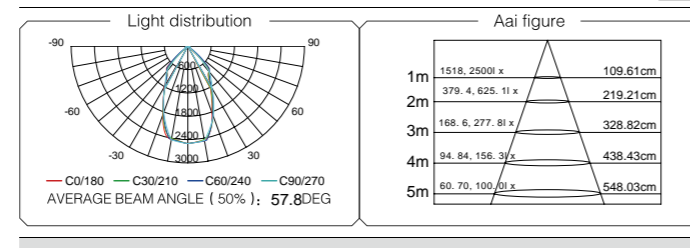

Model	Power (W)	Voltage (V)	CRI(±5%)	PF	Lumen(±10%)	Size (Φmm)	Cut Out (Φmm)
LXM2162C	9W/12W	220~240	80	0.9	850/1100	110	90
LXM2163C	12W/15W	220~240	80	0.9	1100/1350	140	125
LXM2164C	22W/28W/30W	220~240	80	0.9	2000/2550/2700	162	145
LXM2165C	22W/28W/30W	220~240	80	0.9	2000/2550/2700	193	165
LXM2166C	28W/30W/33W	220~240	80	0.9	2550/2700/3000	230	200



BESTYLE
LIGHTING
CE RoHS



LXM2165S

220V 240V	50/60 Hz	15W 18W 23W	3000K 4000K 5000K	1350lm 1700lm 2100lm	Ra > 80	PF 0.90	

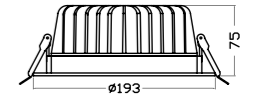

23W

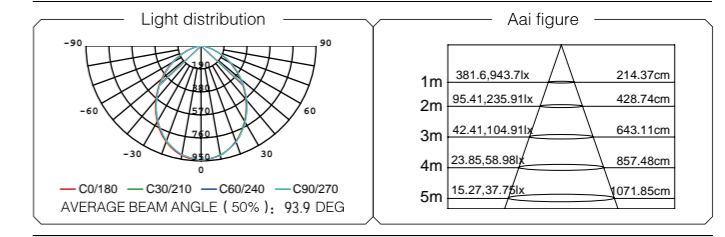

Model	Power (W)	Voltage (V)	CRI(±5%)	PF	Lumen(±10%)	Size (Φmm)	Cut Out (Φmm)
LXM2162S	9W/12W	220~240	80	0.9	850/1100	110	90
LXM2163S	12W/15W	220~240	80	0.9	1100/1350	140	125
LXM2164S	15W/18W	220~240	80	0.9	1350/1700	162	145
LXM2165S	15W/18W/23W	220~240	80	0.9	1350/1700/2100	193	165
LXM2166S	18W/23W/29W	220~240	80	0.9	1700/2100/2700	230	200

SMD

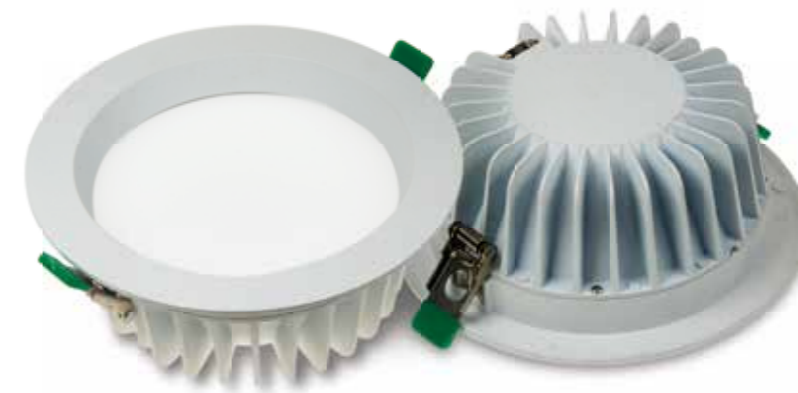



LXM2009

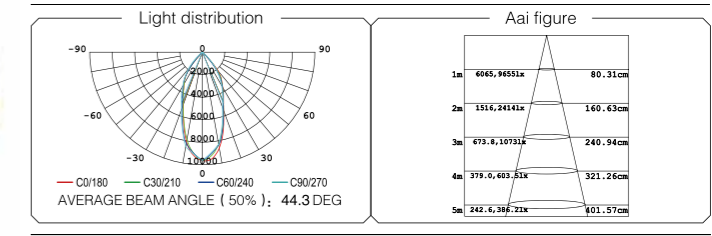
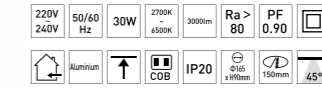

Model	Power (W)	Voltage (V)	CRI(±5%)	PF	Lumen(±10%)	Size (Φmm)	Cut Out (Φmm)
LXM2006	10	220~240	80	0.9	1000	Φ90xH55	75
LXM2007	15	220~240	80	0.9	1500	Φ115xH60	100
LXM2008	20	220~240	80	0.9	2000	Φ140xH75	125
LXM2009	30	220~240	80	0.9	3000	Φ165xH90	150
LXM2010	40	220~240	80	0.9	4000	Φ195xH105	180



LXM2004

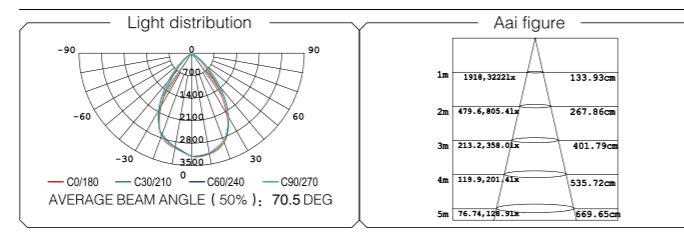
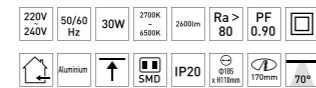

Model	Power (W)	Voltage (V)	CRI(±5%)	PF	Lumen(±10%)	Size (Φmm)	Cut Out (Φmm)
LXM2000	7	220~240	80	0.9	600	Φ83xH45	70
LXM2001	12	220~240	80	0.9	1000	Φ120xH59	105
LXM2002	15	220~240	80	0.9	1300	Φ132xH66	115
LXM2003	20	220~240	80	0.9	1700	Φ160xH88	145
LXM2004	30	220~240	80	0.9	2600	Φ185xH110	170
LXM2005-42	42	220~240	80	0.9	3500	Φ217xH121	200

LXM2015-30

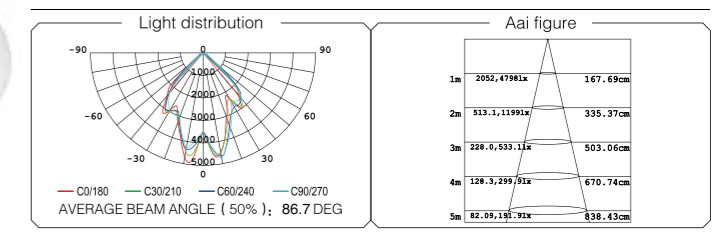

Model	Power (W)	Voltage (V)	CRI(±5%)	PF	Lumen(±10%)	Size (Φmm)	Cut Out (Φmm)
LXM2012	10	220~240	80	0.9	850	Φ95xH58	80
LXM2013	15	220~240	80	0.9	1275	Φ120xH63	105
LXM2014	18	220~240	80	0.9	1530	Φ165xH80	150
LXM2015-30	30	220~240	80	0.9	2550	Φ225xH105	210
LXM2015-50	50	220~240	80	0.9	4250	Φ225xH120	210

Genius

- * LED recessed luminaire - Ultra-thin design! Simple and elegant appearance, round and square version for option.
- * From 2.5 inch to 8 inch size and various powers for different requirement. Dimmable or Non-dimmable available.
- * High CRI, high efficiency, high illumination.
- * Applied to shopping mall, hotel, exhibition hall, museum, office, hospital, airport, school, living and dining room and etc.



LXM2346

LXM2349

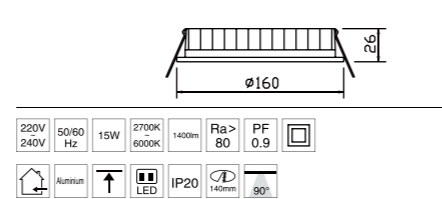
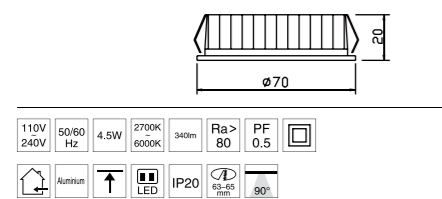

110V 240V	50/60 Hz	4.5W	2700K 6000K	340lm	Ra > 80	PF 0.5	
			IP20		90°		

220V 240V	50/60 Hz	15W	2700K 6000K	1400lm	Ra > 80	PF 0.9	
			IP20		90°		

LXM2347

LXM2350

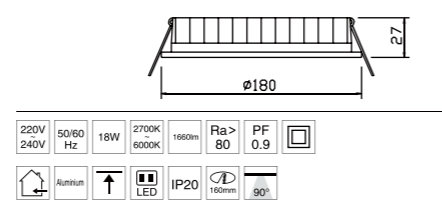
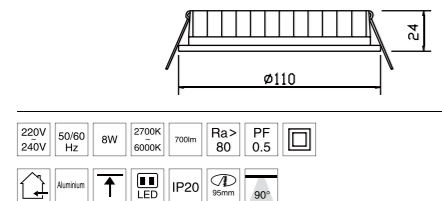

220V 240V	50/60 Hz	8W	2700K 6000K	700lm	Ra > 80	PF 0.5	
			IP20		90°		

220V 240V	50/60 Hz	18W	2700K 6000K	1860lm	Ra > 80	PF 0.9	
			IP20		90°		

LXM2348

LXM2351

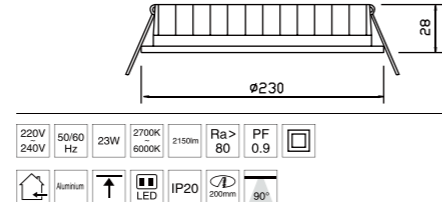
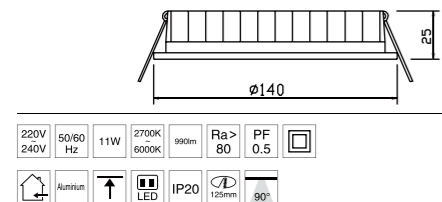

220V 240V	50/60 Hz	11W	2700K 6000K	990lm	Ra > 80	PF 0.5	
			IP20		90°		

220V 240V	50/60 Hz	23W	2700K 6000K	2150lm	Ra > 80	PF 0.9	
			IP20		90°		

LXM2346F

LXM2349F

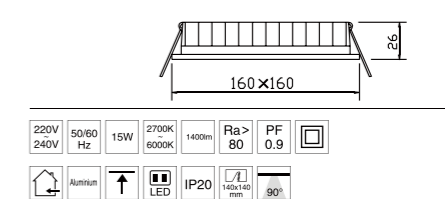
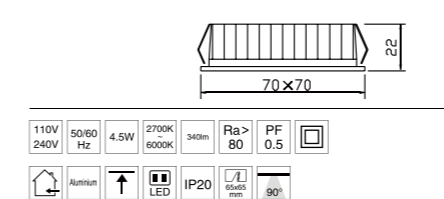

110V 240V	50/60 Hz	4.5W	2700K 6000K	340lm	Ra > 80	PF 0.5	
			IP20		90°		

220V 240V	50/60 Hz	15W	2700K 6000K	1400lm	Ra > 80	PF 0.9	
			IP20		90°		

LXM2347F

LXM2350F

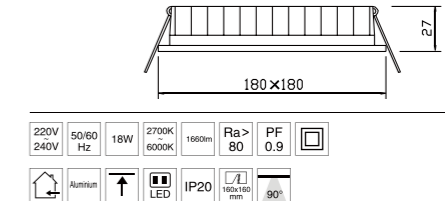
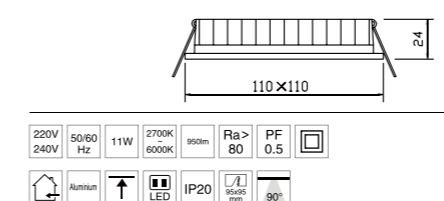

220V 240V	50/60 Hz	11W	2700K 6000K	990lm	Ra > 80	PF 0.5	
			IP20		90°		

220V 240V	50/60 Hz	18W	2700K 6000K	1860lm	Ra > 80	PF 0.9	
			IP20		90°		

LXM2348F

LXM2351F

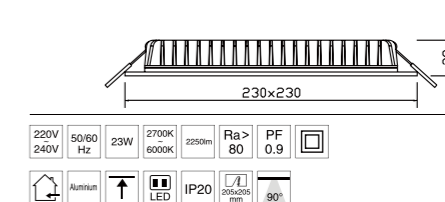
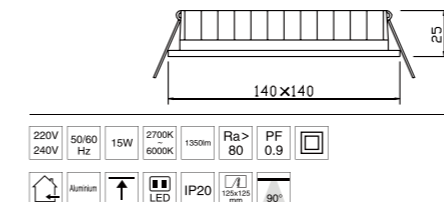

220V 240V	50/60 Hz	15W	2700K 6000K	1350lm	Ra > 80	PF 0.9	
			IP20		90°		

220V 240V	50/60 Hz	23W	2700K 6000K	2250lm	Ra > 80	PF 0.9	
			IP20		90°		

Slim

- * LED recessed luminaire – Slimmer and fashionable appearance with an easy structure.
- * Easy to install, exactly replace the traditional lights.
- * Various sizes, powers available for different requirements.
- * Remote control is optional as your requirement.
- * Applied to shopping mall, hotel, museum, office, hospital, school, living and dining room and etc.

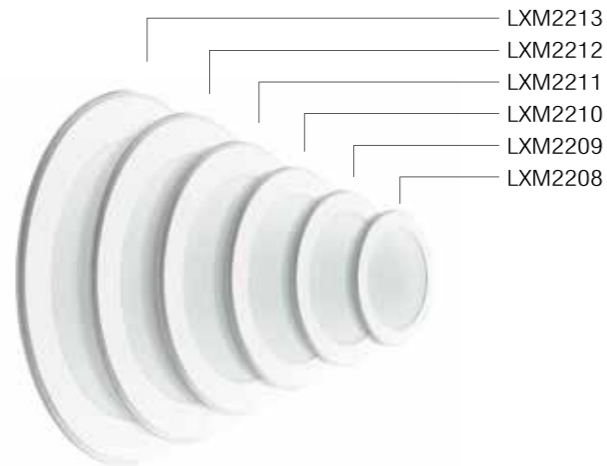

Model	Power (W)	Voltage (V)	CRI(±5%)	PF	Lumen(±10%)	Size (Φmm)	Cut Out (Φmm)
LXM2208	3	100~240	80	0.5	210	Φ85x18	Φ73
LXM2209	6	100~240	80	0.5	450	Φ122x18	Φ110
LXM2210	9	100~240	80	0.5	675	Φ147x18	Φ135
LXM2211	12	100~240	80	0.5	960	Φ170x18	Φ158
LXM2212	15	100~240	80	0.5	1200	Φ190x18	Φ180
LXM2213	18	100~240	80	0.5	1440	Φ225x18	Φ210

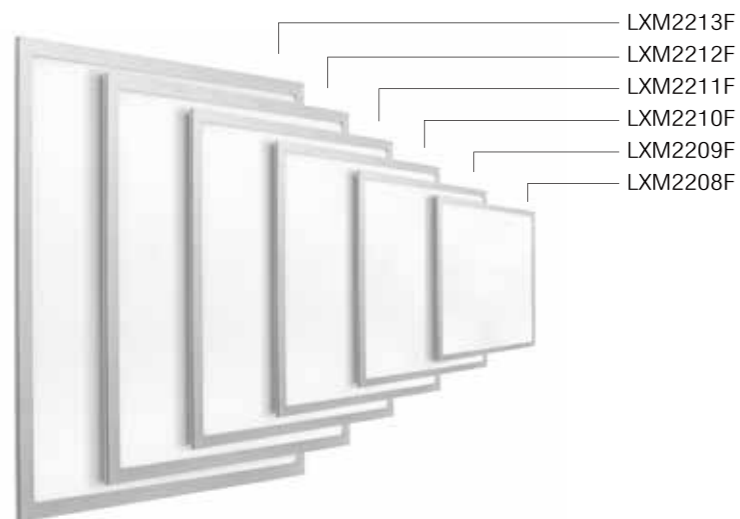

Model	Power (W)	Voltage (V)	CRI(±5%)	PF	Lumen(±10%)	Size (Φmm)	Cut Out (Φmm)
LXM2208F	3	100~240	80	0.5	210	85x85x20	73x73
LXM2209F	6	100~240	80	0.5	450	120x120x20	110x110
LXM2210F	9	100~240	80	0.5	675	147x147x20	135x135
LXM2211F	12	100~240	80	0.5	960	170x170x20	158x158
LXM2212F	15	100~240	80	0.5	1200	190x190x20	180x180
LXM2213F	18	100~240	80	0.5	1440	225x225x20	210x210



Model	Power (W)	Voltage (V)	CRI(±5%)	PF	Lumen(±10%)	Size (Φmm)	Cut Out (Φmm)
LXM6060	40	110~240	80	0.9	3300	600x600	595x595
LXM3012	40	110~240	80	0.9	3300	300x1200	295x1195

Nova

- * LED recessed luminaire - Simple and elegant appearance, fixed and movable version for option.
- * Excellent heat dissipation, various powers meet different requirements.
- * Dimmable or Non-dimmable available.
- * High CRI, high efficiency, high illumination.
- * Applied to shopping mall, hotel, exhibition hall, museum, office, living and dining room and etc.



LBS3000

220V 240V	50/60 Hz	8W	2700K - 6500K	440lm	Ra > 80	PF 0.95	36°
Aluminum	↑	COB	IP20	15°	80mm	92x H43mm	

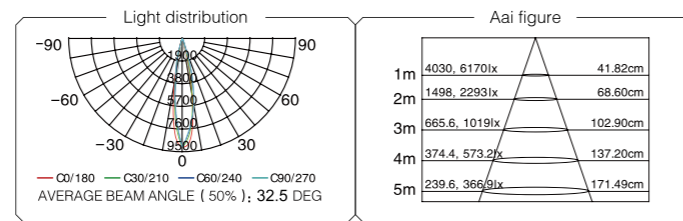

LBS3001

220V 240V	50/60 Hz	5W	2700K - 6500K	400lm	Ra > 80	PF 0.9	36°
Aluminum	↑	COB	IP20	15°	75mm	92x H43mm	



LBS3002

220V 240V	50/60 Hz	7W	2700K - 6500K	540lm	Ra > 80	PF 0.9	36°
Aluminum	↑	COB	IP20	15°	80mm	92x H43mm	



LBS3003

220V 240V	50/60 Hz	5W	2700K - 6500K	400lm	Ra > 80	PF 0.9	36°
Aluminum	↑	COB	IP20	15°	70mm	92x H43mm	



LBS3401

220V 240V	50/60 Hz	7W	2700K - 6500K	540lm	Ra > 80	PF 0.9	36°
Aluminum	↑	COB	IP44	15°	70mm	92x H43mm	



LBS3004

220V 240V	50/60 Hz	7W	2700K - 6500K	540lm	Ra > 80	PF 0.9	36°
Aluminum	↑	COB	IP20	15°	75mm	92x H43mm	



LBS3406

220V 240V	50/60 Hz	7W	2700K - 6500K	540lm	Ra > 80	PF 0.9	36°
Aluminum	↑	COB	IP44	15°	70mm	92x H43mm	



LBS3005

220V 240V	50/60 Hz	12W	3000K - 6500K	1000lm	Ra > 80	PF 0.9	36°
Aluminum	↑	COB	IP20	350°	92x H43mm	92x H43mm	



LBS3006

220V 240V	50/60 Hz	15W	3000K - 6500K	1300lm	Ra > 80	PF 0.9	36°
Aluminum	↑	COB	IP20	350°	92x H43mm	92x H43mm	



Pure

* Spot light fixture - Multiple functional designs for option.
 * For various lighting sources, both traditional and LED bulb.
 * Applied to shopping mall, hotel, exhibition hall, museum, office, hospital, airport, school, living and dining room and etc.



BS3102 \ominus 75mm \oslash 65mm



BS3103 \ominus 92mm \oslash 75mm



BS3104 \square 92X92mm \oslash 75mm



BS3111 \ominus 65mm \oslash 60mm



BS3112 \ominus 80mm \oslash 65mm

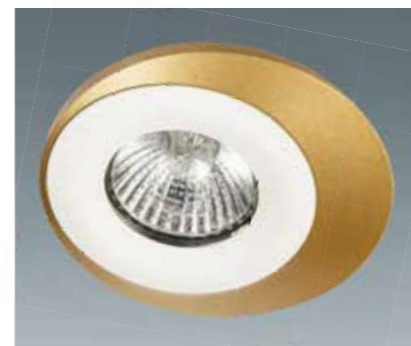

BS3113 \ominus 102mm \oslash 68mm



Push-in Aluminium die casting



BS3162L-N \ominus 77mm \oslash 65mm



BS3159L-N \square 74X74mm \oslash 65mm



BS3254L-N \ominus 84mm \oslash 75mm



BS3261L-N \square 83X83mm \oslash 75mm



BS3297L-N \ominus 97mm \oslash 85mm

High End Aluminium



BS3265CA \ominus 92mm \oslash 80mm



BS3265CF \square 92X92mm \oslash 80mm



BS3209W-A \ominus 90mm \oslash 75mm



BS3152B \ominus 92mm \oslash 80mm



BS3152BF \square 92X92mm \oslash 80mm



**Anti-glare
& Narrow Edge**

Aluminium die casting



BS3198L \ominus 83mm \oslash 72mm



BS3198FL \boxplus 83x83mm \oslash 72mm



BS3197XL-A \ominus 83mm \oslash 75mm



BS3197FXL-A \boxplus 88x88mm \boxtimes 80x80mm



BS3297XL-A \ominus 83mm \oslash 75mm



BS3297FXL-A \boxplus 88x88mm \boxtimes 80x80mm



BS3100L \ominus 99mm \oslash 90mm



BS3100FL \boxplus 99x99mm \boxtimes 90x90mm



Frameless

Aluminium die casting



BS3223L \ominus 150mm \oslash 125mm



BS3223FL \boxplus 150x150mm \boxtimes 125x125mm



BS3224L \ominus 120mm \oslash 83mm



BS3224FL \boxplus 120x120mm \boxtimes 83x83mm

Gypsum



BS9601 \ominus 130mm \oslash 125mm

Gypsum



BS9201 \boxplus 120x120mm \boxtimes 110x110mm



Spot Light Fixture

Waterproof

Aluminium



BS3401L ⊖84mm ⊕72mm



BS3401DL ⊖84mm ⊕72mm



BS3415 ⊖84mm ⊕64mm



BS3406L ⊓82X82mm ⊕72mm



BS3406DL ⊓85X85mm ⊕72mm



BS3415F ⊓84X84mm ⊕64mm



Clip

Aluminium die casting



BS3162L ⊖78mm ⊕64mm



BS3159L ⊓75X75mm ⊕64mm



BS3254L ⊖84mm ⊕75mm



BS3261L ⊓83X83mm ⊕76mm

Revolve

Aluminium die casting



BS3155L ⊖78mm ⊕70mm



BS3159NL ⊓80X80mm ⊕72mm



BS3256L ⊖95mm ⊕80mm



BS3261ML ⊓95X95mm ⊕80mm

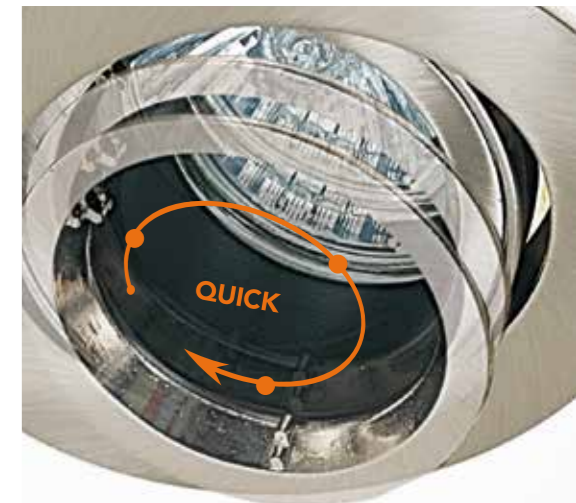

Metal



BS3162S ⊖80mm ⊘55mm



BS3159S ⊠75X75mm ⊘60mm



BS3254S ⊖83mm ⊘70mm



BS3261S ⊠83X83mm ⊘70mm



BS3110K ⊖80mm ⊘65mm



BS3206 ⊖105mm ⊘80mm



BS3215 ⊖96mm ⊘80mm



BS3320A ⊖107mm ⊘80mm

Multi-function

Aluminium / Metal Ring

RECESSED MOUNTED



BS3601SA ⊠148x148mm ⊠120x120mm



BS3602SA ⊠245x148mm ⊠220x120mm



BS3603SA ⊠345x148mm ⊠315x120mm



BS3604SA ⊠250x250mm ⊠230x230mm

FRAMELESS



BS3601SA-H ⊠100x100mm ⊠102x102mm



BS3602SA-H ⊠200x100mm ⊠202x102mm



BS3603SA-H ⊠300x100mm ⊠302x102mm



BS3604SA-H ⊠220x220mm ⊠222x222mm

SURFACE MOUNTED



BS3601M ⊠115x115x96mm



BS3602M ⊠218x115x96mm



Casa

* LED luminaire - Various powers for different requirement. Round and rectangle for optional.
 * High CRI, high efficiency, high illumination.
 * Applied to shopping mall, hotel, exhibition hall, museum, hospital, airport, school and etc.



LBS3148

220V 240V	50/60 Hz	15W	4000K	1700lm	Ra > 80	PF 0.95
Aluminum	COB	IP20	90°	15mm	24°	

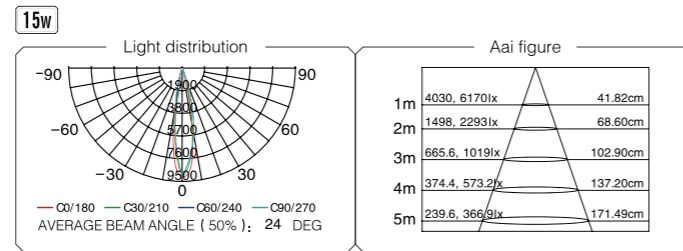
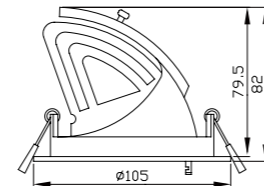

LBS3149

220V 240V	50/60 Hz	24W	4000K	2600lm	Ra > 80	PF 0.95
Aluminum	COB	IP20	90°	12mm	24°	

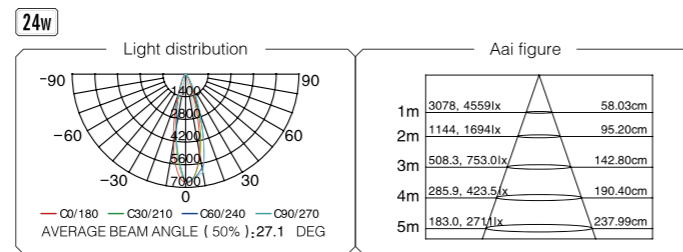
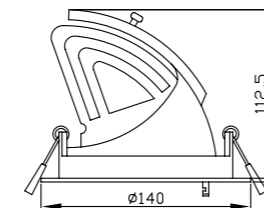

LBS3150

220V 240V	50/60 Hz	38W	4000K	4200lm	Ra > 80	PF 0.95
Aluminum	COB	IP20	90°	14mm	38°	

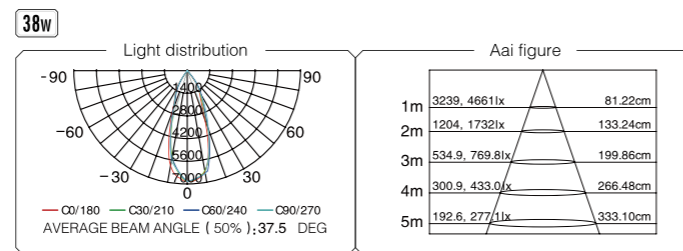
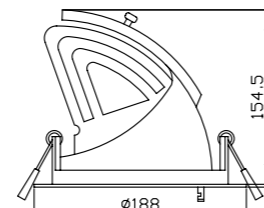

LBS3167

220V 240V	50/60 Hz	15W	4000K	900lm	Ra > 95	PF 0.5
Aluminum	COB	IP20	90°	15mm	24°	

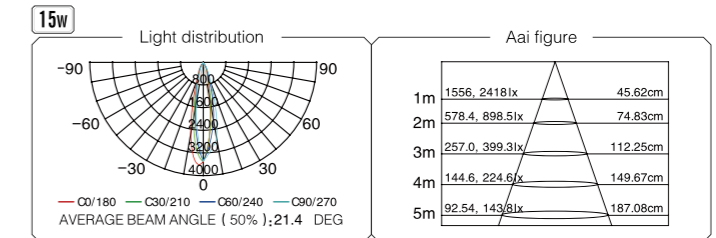
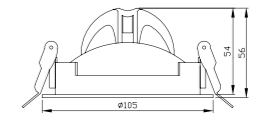

LBS3168

220V 240V	50/60 Hz	30W	4000K	2500lm	Ra > 80	PF 0.95
Aluminum	COB	IP20	90°	14mm	24°	

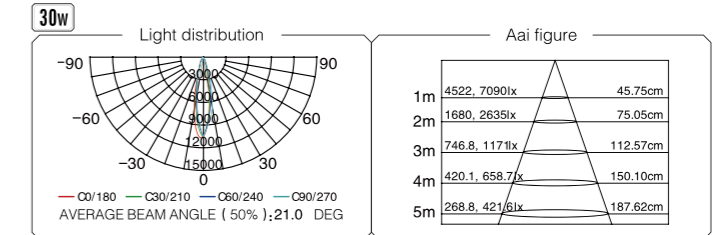
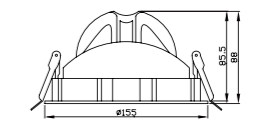

LBS3169

220V 240V	50/60 Hz	15W	4000K	900lm	Ra > 95	PF 0.5
Aluminum	COB	IP20	90°	15x15mm	24°	

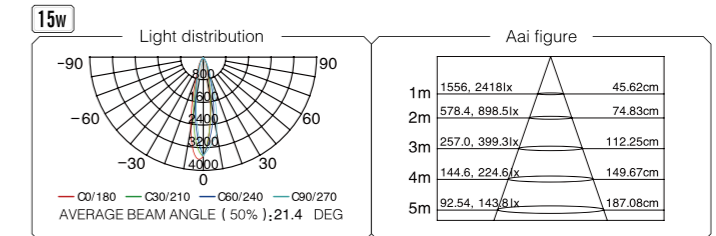
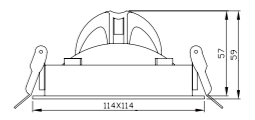

LBS3170

220V 240V	50/60 Hz	30W	4000K	2500lm	Ra > 80	PF 0.95
Aluminum	COB	IP20	90°	15x15mm	24°	

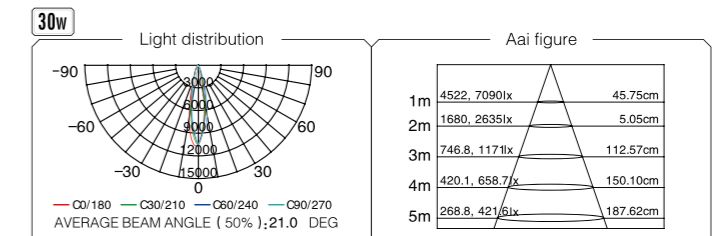
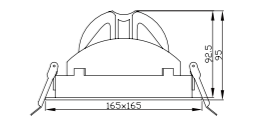



Link

- * Recessed luminaire - Creative and genius design. The flexible installation way breaks the limit of traditional lights on size, combination, stock, and delivery.
- * Any shape you can make decision, A small stock is enough.
- * LED and tradition light source available for different requirements.
- * Applied to shopping mall, hotel, exhibition hall, museum, airport, and etc.



Standard Parts

1. Frame
2. Spring
3. Distance Bar
4. Heads For Different Sources
5. Connector



Lamp Sources Combination

New design includes several lamp sources CDM-T, CDM-R, CDM-R111, PAR30, QR111 and PLC, etc. You can easily make different combinations to get different effects.

New Structure For LED Sources



XM2488-AR

220V 240V	50/60 Hz	15W	3000K 4000K	Ra > 80	PF 0.9	□
Aluminum	↑	COB	IP20	170x140 mm		



XM2488-PA

220V 240V	50/60 Hz	13W	3000K 4000K	1100lm	Ra > 80	PF 0.9	□
Aluminum	↑	COB	IP20	170x140 mm			



LED PAR 30

LED AR111

LED Module



LXM2488

220V 240V	50/60 Hz	20W	4000K	1400lm	Ra > 80	PF 0.9	□
Aluminum	↑	COB	IP20	170x140 mm	38°		

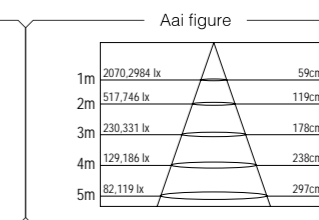
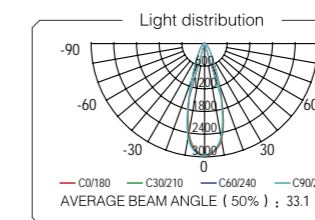
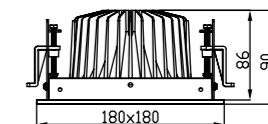

XM2488

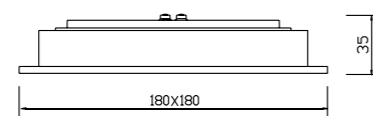

□	Aluminum	↑	IP20	45°	170x170 mm
---	----------	---	------	-----	---------------





Standard Parts

- 1.Connector
- 2.Spring
- 3.Frame

New design includes two LED lamp sources AR111 and Par30. You can easily make different combinations to get different effects.



LED PAR 30

LED AR111



XM2488A-AR

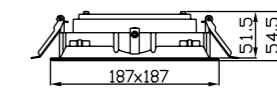

220V 240V	50/60 Hz	15W	3000K 4000K	Ra > 80	PF 0.9	
			IP20			



XM2488A-PA

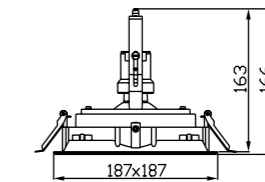

220V 240V	50/60 Hz	13W	3000K 4000K	Ra > 80	PF 0.9	
			IP20			



LXM2488A

220V 240V	50/60 Hz	20W	4000K	1400lm	Ra > 80	PF 0.9	
			IP20				

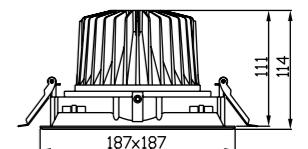

Light distribution

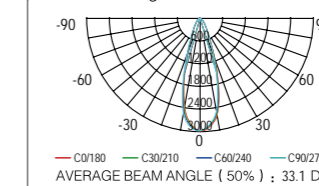

Aai figure

1m	2070,2984 lx	59cm
2m	517,746 lx	119cm
3m	230,331 lx	178cm
4m	129,186 lx	238cm
5m	82,119 lx	297cm

Pro

* Commercial recessed luminaire - Classic design, round and square version for option.
 * Size fits for various lighting sources, both traditional and LED bulb.
 * Applied to shopping mall, hotel, exhibition hall, museum, office and etc.



XM2489-Q

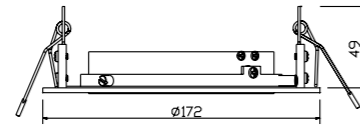

XM2479-2

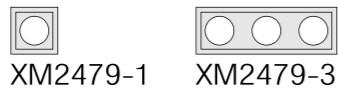
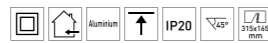

XM2479-1 XM2479-3



XM2481C-2

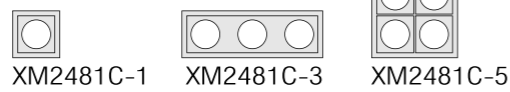
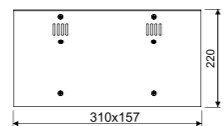

XM2481C-1 XM2481C-3 XM2481C-5

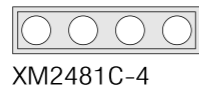

XM2481C-4

SUITABLE LIGHTING SOURCE



Multi-function

RECESSED MOUNTED



XM2901S-N 1 191x191mm 1 165x165mm

FRAMELESS



XM2901S-H 1 150x150mm 1 152x152mm

SURFACE MOUNTED



XM2901S-M 1 160x160x123mm



XM2902S-N 1 345x191mm 1 315x165mm



XM2902S-H 1 300x150mm 1 302x152mm



XM2902S-M 1 312x160x123mm



XM2903S-N 1 495x191mm 1 465x165mm



XM2903S-H 1 440x150mm 1 442x152mm



XM2904S-N 1 340x340mm 1 315x315mm



XM2904S-H 1 300x300mm 1 302x302mm



Pro

- * Commercial recessed & trimless luminaire - Classic design, round and square version for option.
- * Size fits for various lighting sources, both traditional and LED bulb.
- * Applied to shopping mall, hotel, exhibition hall, museum, office and etc.



XM2901SA-N

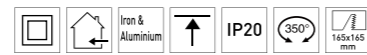
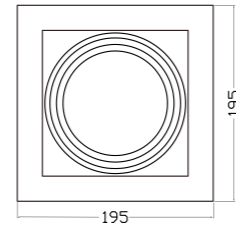

XM2902SA-N

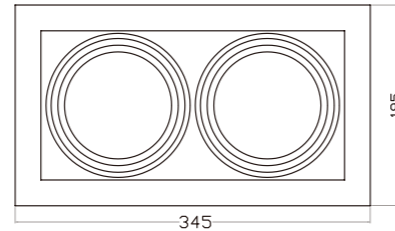

XM2901SA-H

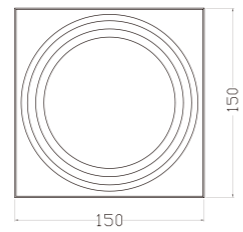

XM2902SA-H

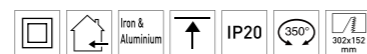
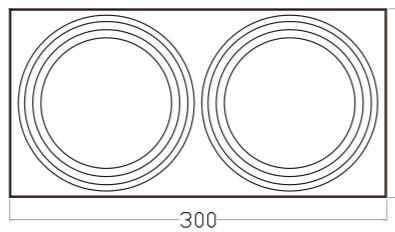

Vinci



LED Wall Light

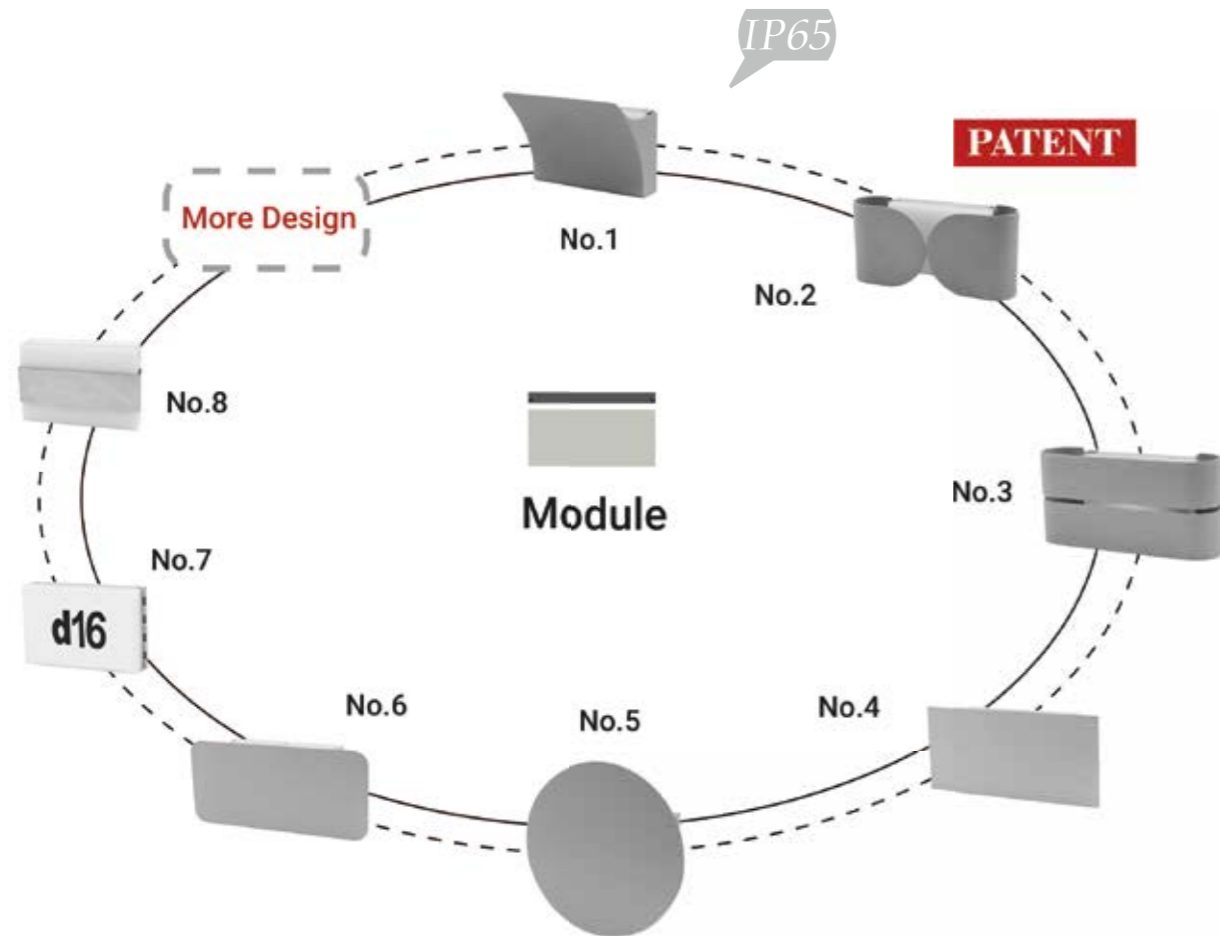

Before



After

SAVE YOUR COST AND STOCK



LBS9247 150×120×103mm LBS9248 210×100×44mm LBS9252 210×100×44mm



LBS9250 215×100×75mm LBS9249 215×100×75mm LBS9251 Ø180×43mm



LBS9255 220×115×62mm LBS9256 245×135×62mm LBS9257 Ø230×62mm



LBS9253 140×90×35mm LBS9254 135×90×33mm LBS9270 135×90×33mm



LBS9254-N 135×90×33mm LBS9258 230×240×150mm LBS9259 147×110×96mm

No.Q

- * LED wall light - Fashionable and elegant appearance
- * Functional & humanized design
- * High quality, high efficiency
- * Applied to shopping mall, hotel, museum, dining room, etc.

LBS9246

Size:275x92x66mm Max 8W



HALF POWER

When upwards model or downwards model
Energy saving!

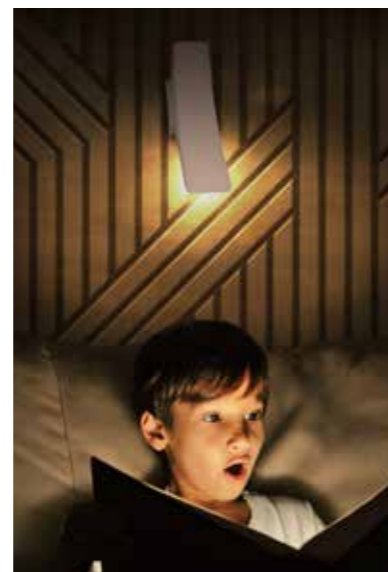

Design your wall as you want!



Easy installation

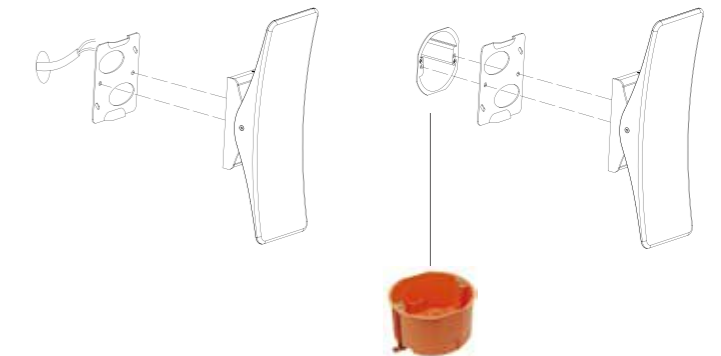

Coming Soon...

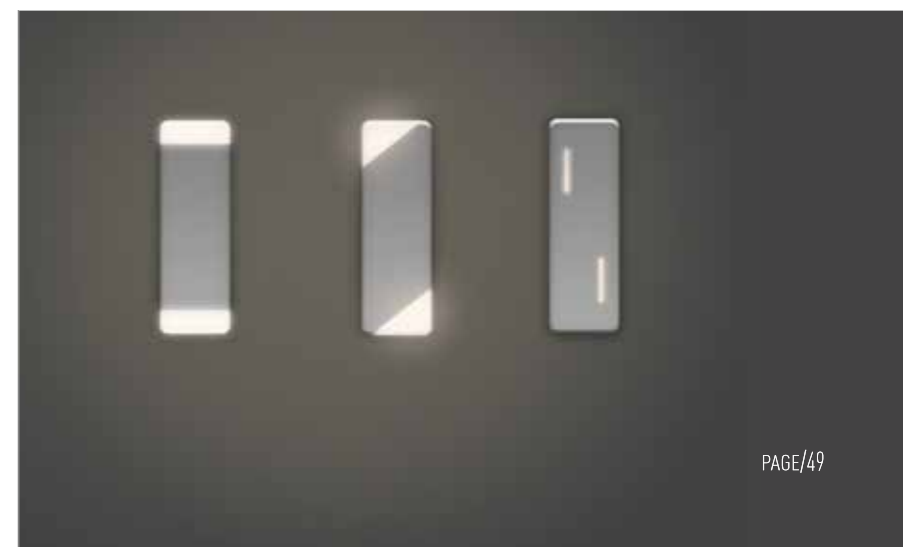

Super

*LED wall / spike luminaire - Classic design, hot sale!
 *Same head design for different functions.
 *Applied to shopping mall, hotel, exhibition hall, museum, garden, villa and etc.



Light up and down



Clock

- * LED wall luminaire - Cover-replace design. Magnetic structure makes cover change comes true.
- * Same base, save your money & stock. Round & square, whole series for selection.
- * High IP protection, IP54.
- * Applied to shopping mall, hotel, exhibition hall, museum, office, residential area, garden, villa.

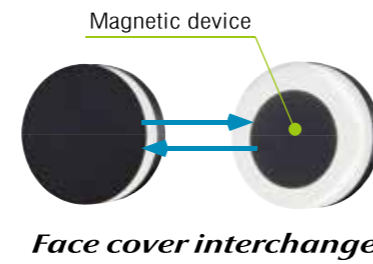

LBS9313-A
Ø145X48mm



LBS9313-B
Ø145X48mm



LBS9314-A
135x135X48mm



LBS9314-B
135x135X48mm



IP67
LBS9265
Ø50×87mm 2.5W

IP67
LBS9266
Ø50×87mm 2.5W

IP67
LBS9267
50×50×87mm 2.5W

Star

- *LED wall luminaire - Fashionable appearance, round and square for option.
- High IP protection, IP67.
- *Applied to shopping mall, hotel, exhibition hall, museum, office, hospital, airport, school and etc.



Smart

- * LED wall luminaire - Fashionable and elegant appearance, round and square for option.
- * Different powers and IP for different requirement.
- * Applied to shopping mall, hotel, exhibition hall, museum, office, hospital, airport, school and etc.



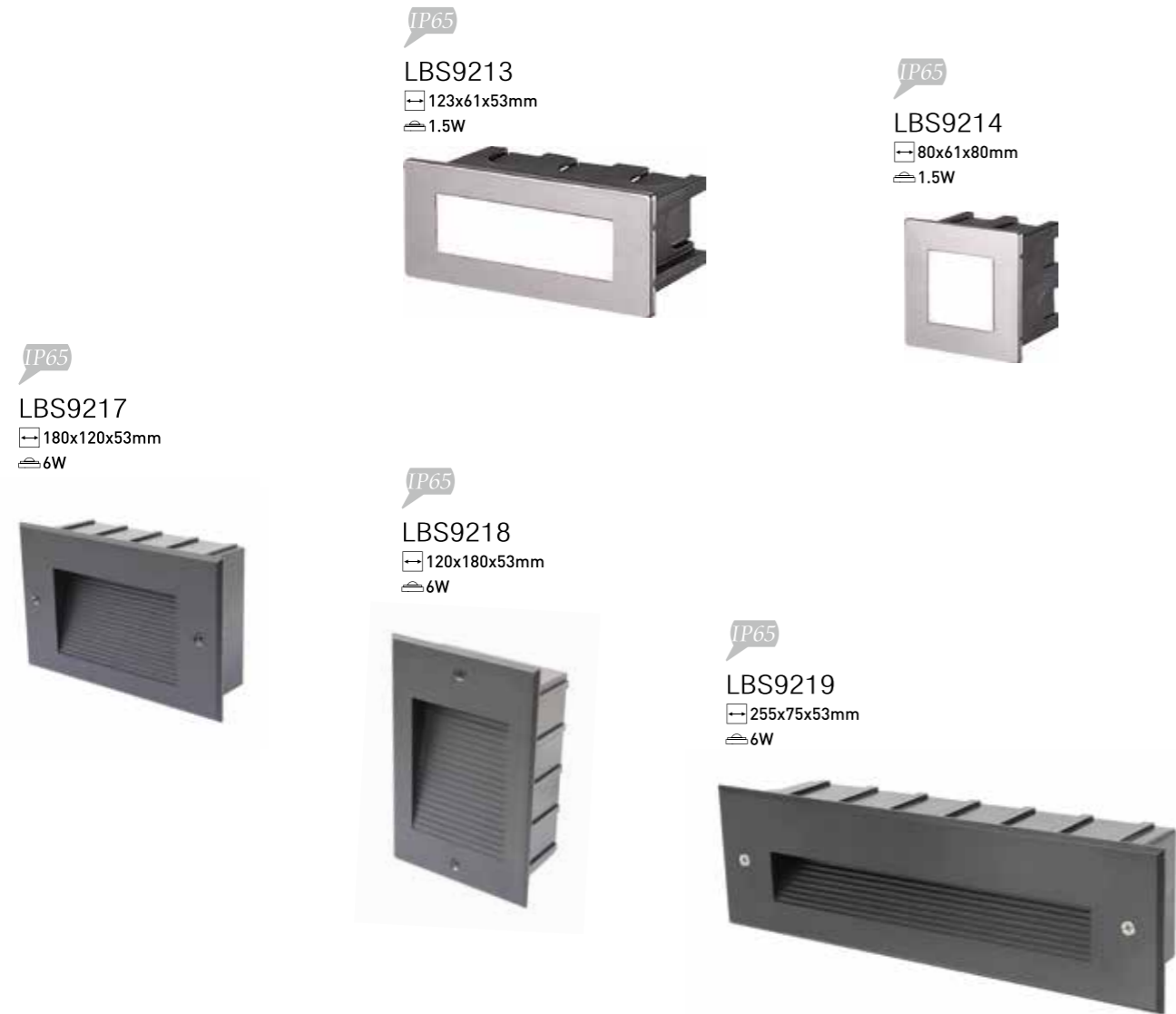

Laser

- * LED wall luminaire - Fashionable and perfect appearance.
- * Round and square version for option, recessed and surface mount for option.
- * High IP level.
- * Applied to shopping mall, hotel, exhibition hall, museum, office, and etc.

LBS9207-4
IP54
Φ91mm 6W



LBS9261
IP65
Φ60mm 3W

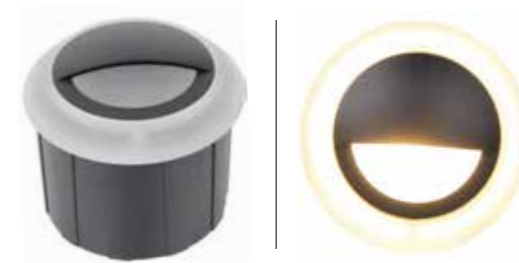

LBS9262
IP65
Φ60mm 3W



LBS9261F
IP65
60x60mm 3W

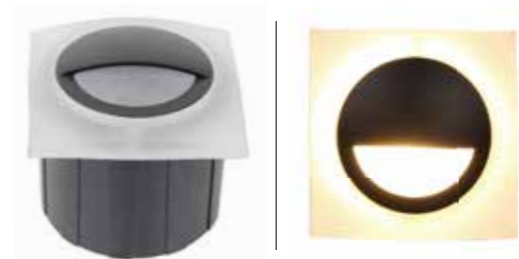

LBS9262F
IP65
60x60mm 3W



Paris

- * Wall light, modern design, round & square for option.
- * E27 lampholder, IP65
- * Applied to hotel, garden, villa and etc.



IP54 E27

BS9330
Size: Ø165x230x180mm



IP54 E27

BS9331
Size: 210x230x185mm

IP65 E27

BS9706
Size: Ø160x215x276mm



IP65 E27

BS9706F
Size: 145x215x276mm



IP65 E27

BS9707
Size: Ø135x202x260mm



IP65 E27

BS9708
Size: Ø160x215x250mm





LBS9264 ^{IP54}
95 × 75 × 200mm 10W

Torch

*LED wall / garden luminaire - Unique design.
*Same head design for different functions.
*Applied to hotel, garden, villa and etc.



^{IP54}
LXM9914
95 × 45 × 650mm 10W



LBS9317
145x100x220mm



LXM9928
145x100x800mm



Arch

*LED wall / garden luminaire - Unique design.
*Same head design for different functions.
*Applied to hotel, garden, villa and etc.



LXM9920
120×50×1000mm

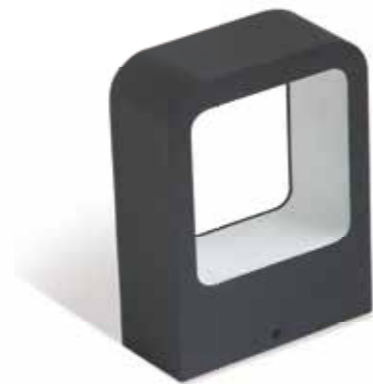

LBS9309
120×50×180mm



Rise

*LED garden luminaire - Unique design.
*Different heights for option.
*Applied to hotel, garden, villa and etc.



LXM9921-800
70×110×800mm

LXM9921-600
70×110×600mm

Jardin

- * LED outdoor luminaire - Simple and elegant appearance. Pole Light/ Garden Light/ Stake Light.
- * High quality, high IP Level, high efficiency.
- * Applied to garden, park or other outdoor area.



LXM9915-750
Φ108×750mm

LXM9915-550
Φ108×550mm

LXM9915-350
Φ108×350mm



XM9930
Size: Ø135x800mm



Solar

Solar

- Battery
- Sensor
- Model 3

- Standby 60lm
- Standby 60lm + motion 350lm x 25s
- Motion 480lm x 25s

IP44
LBL9700
Size: 200x110x68mm 6W



IP44
LBL9701
Size: 205x106x40mm 6W



Solar

- Battery
- Sensor
- Model 3

- Standby 60lm
- Standby 60lm + motion 350lm x 25s
- Motion 480lm x 25s



IP44
LBL9702
Size: 188x158x70mm 6W

Model 2

- 10lm/50lm/120lm
- MIN 5 SEC
- MAX 15 MIN

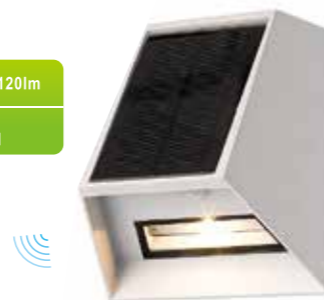

IP65
LBL9705
Size: 130x74x134mm 2W



IP44
LBL9703
Size: ø160x170x170mm 6W

IP44
LXL9750
Size: ø160x850mm 6W





- 1 Standby 60lm
- 2 Standby 60lm + motion 350lm x 25s
- 3 Motion 480lm x 25s



IP44

LBL9704
Size: 170x160x287mm 6W



IP44

LXL9751
Size: ø158x960mm 6W



- 10lm/50lm/120lm
- MIN 5 SEC
MAX 15 MIN



IP65

LBL9707
Size: ø135x202x260mm 2W



IP65

LBL9706
Size: 160x215x235mm 2W



IP65

LBL9706F
Size: 145x208x280mm 2W



IP65

LXL9752
Size: ø160x500mm 2W



IP65

LXL9752F
Size: 145x145x500mm 2W



Jardin



IP65
LXM9105
Size: ø42.5x72mm 3 / 5 / 6W



IP65
LXM9110
⊖ Φ65.5x62.4x303.7mm
⊕ 6W



IP65
LXM9111
⊖ Φ65.5x62.4x322.9mm
⊕ 6W

FOUR USAGES
OF A LAMP



LXM9105D



LXM9105J



LXM9105B



IP65
XM9109C
100x68x268.5mm
GU10



IP65
XM9109
100x68x100mm
GU10

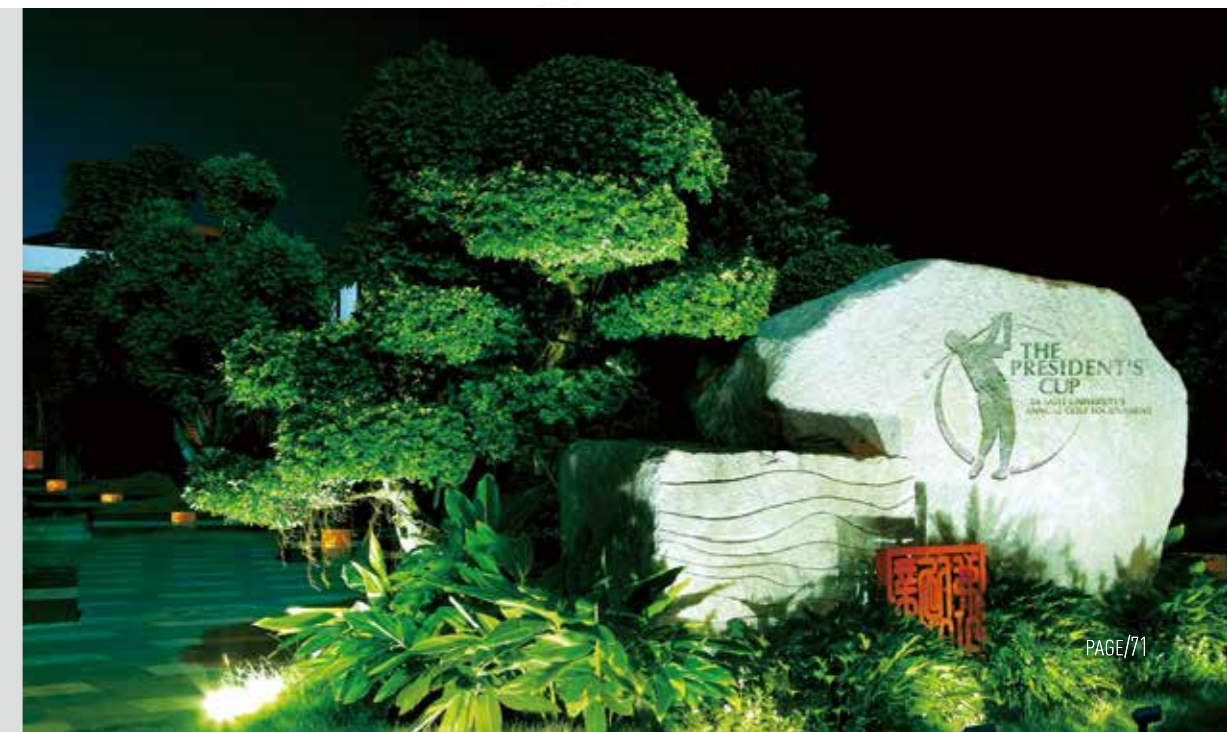

Halo

* LED ground luminaire – Fashionable and elegant appearance, family design, high quality.
 * Different powers and IP for different requirement.
 * Applied to outdoor square, grassplot and etc.



LBS9206B
 ⊖110mm ⊕76mm ≙ 1W

LBS9263
 ⊖220mm ⊕55mm ≙ 7.2W

SMD

Wall Light



IP67

IP67

LXM1019-1
 ⊖90mm ⊕75mm ≙ 1W

LBS9206-1
 ⊖90mm ⊕75mm ≙ 1W

LXM1019-2
 ⊖90mm ⊕75mm ≙ 1W

LBS9206-2
 ⊖90mm ⊕75mm ≙ 1W

LXM1019-3
 ⊖90mm ⊕75mm ≙ 1W

LBS9206-3
 ⊖90mm ⊕75mm ≙ 1W

LXM1019-4
 ⊖90mm ⊕75mm ≙ 1W

LBS9206-4
 ⊖90mm ⊕75mm ≙ 1W

LXM1019-5
 ⊖90mm ⊕75mm ≙ 1W

LBS9206-5
 ⊖90mm ⊕75mm ≙ 1W

IP65
 Stainless Steel

High Power
CREE



LXM1015 | **LXM1016**
 ⊖52mm ⊕47mm ≙ 1W | ⊖92mm ⊕88mm ≙ 3W

LXM1015-1 | **LXM1016-1**
 ⊖52mm ⊕47mm ≙ 1W | ⊖92mm ⊕88mm ≙ 3W

LXM1015-2 | **LXM1016-2**
 ⊖52mm ⊕47mm ≙ 1W | ⊖92mm ⊕88mm ≙ 3W

LXM1015-3 | **LXM1016-3**
 ⊖52mm ⊕47mm ≙ 1W | ⊖92mm ⊕88mm ≙ 3W

LXM1015-4 | **LXM1016-4**
 ⊖52mm ⊕47mm ≙ 1W | ⊖92mm ⊕88mm ≙ 3W

LED Outdoor Light



Rock

- * LED ground luminaire - Family design, high quality.
- * Modern style, COB & High power light source for option, fashionable and attractive round design. Ideal choice for the modern city night view.
- * Applied to outdoor square, grassplot, plaza, market, dancing hall, park and etc.



Dia



Aluminium+Plastic Version

Model	Power	Voltage	CCT	Lumen(±10%)	Ra(±5%)	PF	Size
GY-2801-9	9W	AC100-240V	2700-6500K	810	>80	>0.5	0.6M
GY-2801-18	18W	AC100-240V	2700-6500K	1700	>80	>0.5	1.2M

Plastic Version

Model	Power	Voltage	CCT	Lumen(±10%)	Ra(±5%)	PF	Size
GY-2804-8	9W	AC100-240V	2700-6500K	720	>80	>0.5	0.6M
GY-2804-18	18W	AC100-240V	2700-6500K	1500	>80	>0.5	1.2M

T8



T5

Model	Power	Voltage	CCT	Lumen(±10%)	Ra(±5%)	PF	Size
LT5-4-4	4W	AC100-240V	2700-6500K	280	>80	>0.5	0.3M
LT5-4-8	8W	AC100-240V	2700-6500K	600	>80	>0.5	0.6M
LT5-4-12	12W	AC100-240V	2700-6500K	960	>80	>0.5	1M
LT5-4-16	16W	AC100-240V	2700-6500K	1280	>80	>0.5	1.2M



GY-2207C

220V 240V	50/60 Hz	5W	2700K - 6000K	400lm	Ra > 80	PF 0.5	
	Aluminium + Plastic	AC-LED	IP20	Gu10			

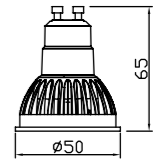

5W

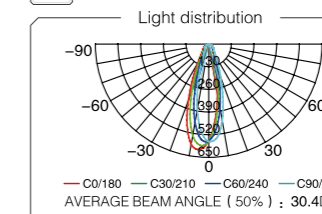

Aai figure

Distance	Beam Diameter	Beam Area
1m	83cm	204, 305 lx
2m	166cm	51, 76 lx
3m	249cm	22, 33 lx
4m	332cm	12, 19 lx
5m	415cm	8, 12 lx



GY-2221

220V 240V	50/60 Hz	7W	2700K - 6000K	400lm	Ra > 80	PF 0.5	
	Aluminium + Plastic	AC-LED	IP20	Gu10			

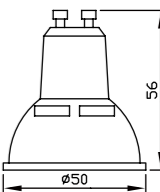

7W

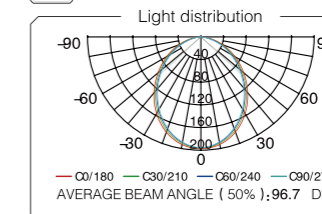

Aai figure

Distance	Beam Diameter	Beam Area
1m	257.17cm	54.42, 133.4lx
2m	421.87cm	20.22, 49.56lx
3m	632.80cm	8.989, 22.02lx
4m	843.74cm	5.056, 12.39lx
5m	1054.67cm	3.236, 7.92lx



GY-2223

100V 240V	50/60 Hz	5W	2700K - 6000K	400lm	Ra > 80	PF 0.5	
	Aluminium + Plastic	AC-LED	IP20	Gu10			

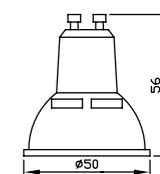

5W

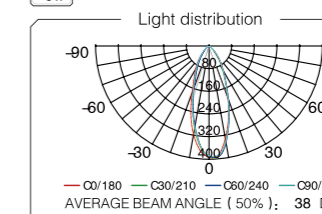

Aai figure

Distance	Beam Diameter	Beam Area
1m	101.45cm	185.2, 287.2lx
2m	135.27cm	104.2, 161.6lx
3m	169.09cm	66.66, 103.4lx
4m	270.54cm	26.04, 40.39lx
5m	338.18cm	16.66, 25.85lx





GY-2401

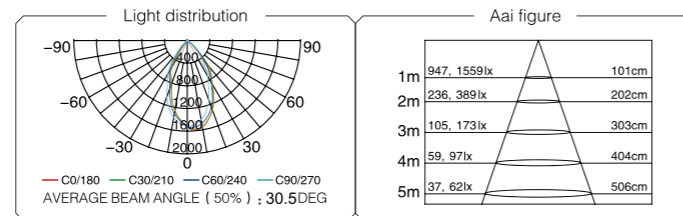
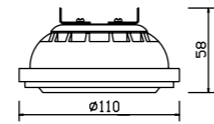
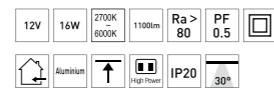

GY-2405

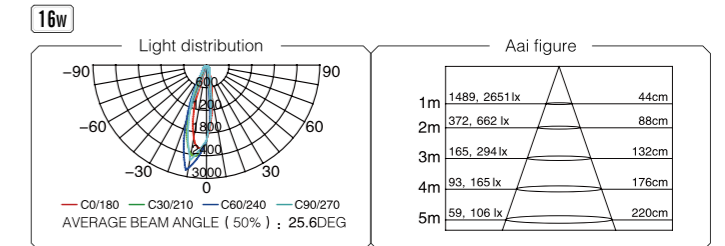
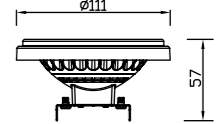
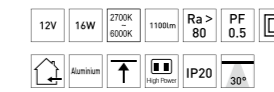

GY-2402

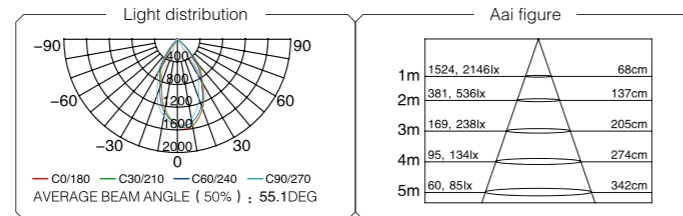
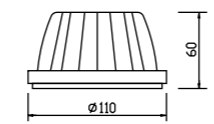

GY-2407

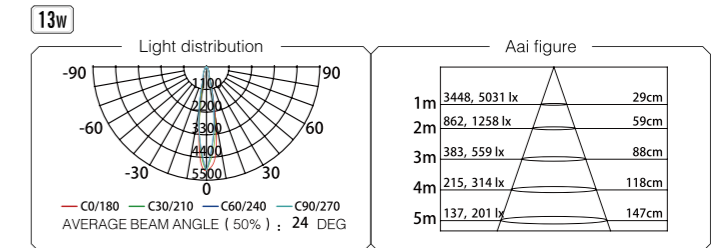
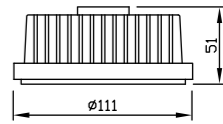
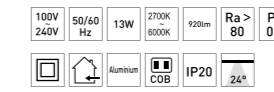

GY-2403

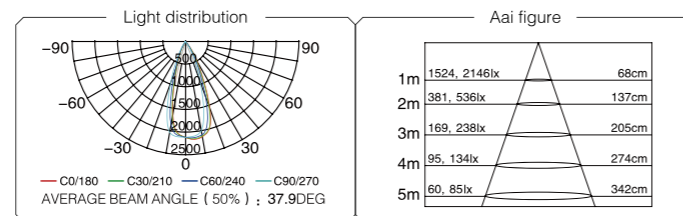
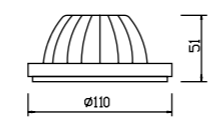

GY-2408

